

MPSC

2024

Maharashtra Public Service Commission Assistant Engineer Examination

Civil Engineering

Building Materials

Well Illustrated **Theory** *with*
Solved Examples and **Practice Questions**



Note: This book contains copyright subject matter to MADE EASY Publications, New Delhi. No part of this book may be reproduced, stored in a retrieval system or transmitted in any form or by any means. Violators are liable to be legally prosecuted.

Building Materials

Contents

UNIT	TOPIC	PAGE NO.
1.	Cement -----	1-28
2.	Concrete -----	29-76
3.	Bricks -----	77-113
4.	Stones -----	114-131
5.	Timber -----	132-157
6.	Aggregates -----	158-168
7.	Mortar and Lime -----	169-178
8.	Structural Steel & Other Construction Materials -----	179-201

○○○○

Cement

1.1 Introduction

- Cement is an extremely fine material having adhesive and cohesive properties which provides a binding medium for the discrete ingredients.
- Cement is a product obtained by pulverizing clinker formed by calcinating raw-materials primarily consisting of lime (CaO), silicate (SiO₂), Alumina (Al₂O₃), and Iron oxide (Fe₂O₃).
- When cement is mixed with water it forms a paste which hardens and bind aggregates (fine coarse) together to form a hard durable mass called concrete.
- Cements used in construction industry can be classified as hydraulic and non-hydraulic.
- Hydraulic cement set and harden extremely fast in presence of water (Due to the chemical action between cement and water known as hydration) and results in water resistance product which is stable. This allows setting in wet condition or underwater and further protects the hardened material from chemical attack. e.g.: (Portland cement).
- Non-hydraulic cements are derived from calcination of gypsum or limestone because their products of hydration are not resistant to water. However, the addition of pozzolanic materials can render the gypsum and make cement hydraulic. Thus, it will not set in wet condition or underwater, rather it sets as it dries and reacts with carbon-dioxide in the air. It can be attacked by some aggressive chemicals after setting. e.g.: Plaster of Paris.
- The cement experiences the exothermic chemical reactions when comes in contact with water.
- The cement is assumed to have a specific gravity of 3.15.
- Standard density of cement is 1440 kg/m³ and 1 bag of cement is of 50 kg, thus volume would be $50/1440 = 0.0347 \text{ m}^3$.
Hence, volume of 1 bag of cement can be approximated as 0.035 m³ or 35 litres.
- Cement can be manufactured either from natural cement stones or artificially by using calcareous and argillaceous materials.

Argillaceous	Calcareous
<ul style="list-style-type: none"> • Shale and clay • Blast furnace slag • Slate 	<ul style="list-style-type: none"> • Cement rock • Limestone • Chalk • Marine shells • Marl

1.2 Cement and Lime

Following points of differences may be noted between ordinary cement and lime:

1. The cement is used for the gain of early strength whereas lime gains the strength slowly.
2. The cement and lime color are different.
3. The cement and lime both is a binding material having good ultimate strength but lime experiences less early strength as compare to cement.

1.3 Manufacturing of Cement

- The manufacturing of cement was first started in England by the scientist named Joseph Aspdin.
- The first time manufacturing of cement is named as Ordinary Portland Cement (OPC) because when the cement comes in contact with water it becomes a hard mass after a certain period and this hard mass resembles the stone found in portland area of England.
- The India is 2nd largest manufacturing hub after China.
- The cement is manufactured by integrating the calcareous component and argillaceous component in ratio 3 : 1.
- The calcareous components can be limestone chalk, marine shells, marl whereas argillaceous components can be shale clay, blast furnace slag, slate.
- The calcareous component is used to derive the ingredient called lime whereas the argillaceous component composed of silica, alumina, iron oxide, and other impurities.
- Cement can be manufactured either by dry process or wet process.

Dry Process

Step (i): The material is gathered from quarry with the help of dumper to manufacturing plant. The material gathered is having content of limestone and clay which is calcareous component and argillaceous component respectively. The material gathered is about more than 80 mm size.

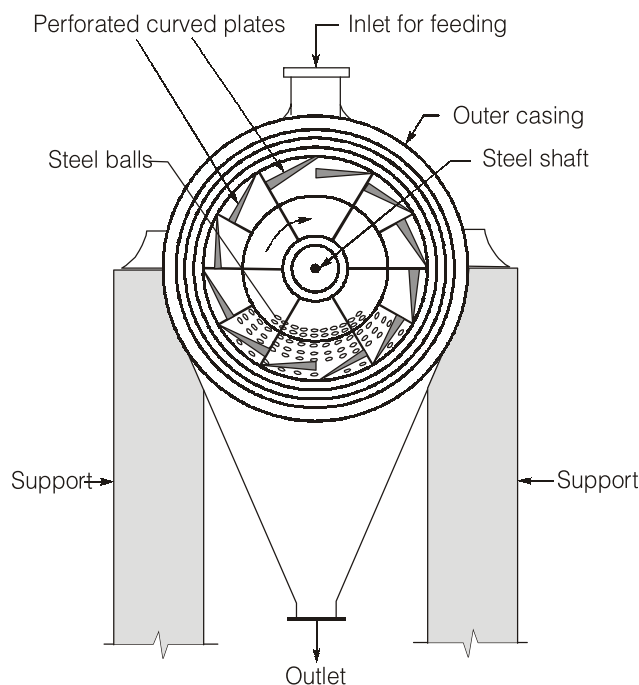

Fig. Vertical Section of a Ball Mill

Step (ii): The collected material is fed into heavy crusher where the size of the material get reduced to 60 mm from 80 mm and later this size material is fed into light crusher (Tubemill/Ballmill) where the size reduced to 40-60 mm finally it is stored in the tank.

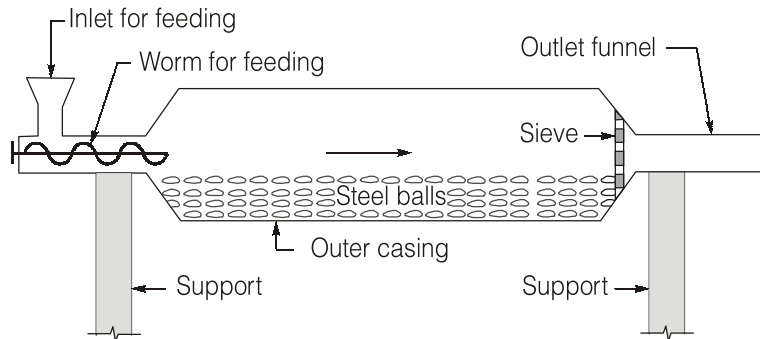

Fig. Longitudinal Section of a Tube Mill

Step (iii): Now, the grinding material called raw mix is fed into preheater (heater before rotary kiln), the temperature is gradually increased upto 500°C due to this increase in temperature the raw mix get fraction into smaller size nearly (25 mm).

Benefits of Preheaters:

- (a) It makes the process fast.
- (b) Fuel consumption is reduced because the burning time of rotary kiln is get reduced.

Now, this raw mix is fed into rotary kiln where the temperature is 800-1000°C, 1000-1200°C, 1200°-1500°C. In three separate zones respectively. The product obtained is of size 8 to 10 mm from rotary kiln is called clinker.

Rotary Kiln

Dimensions:

- Diameter = 3 m
- Length = 100 m
- Revolutions = 3 rounds in 1 minute

Gradient 1 in 25 to 1 in 30.

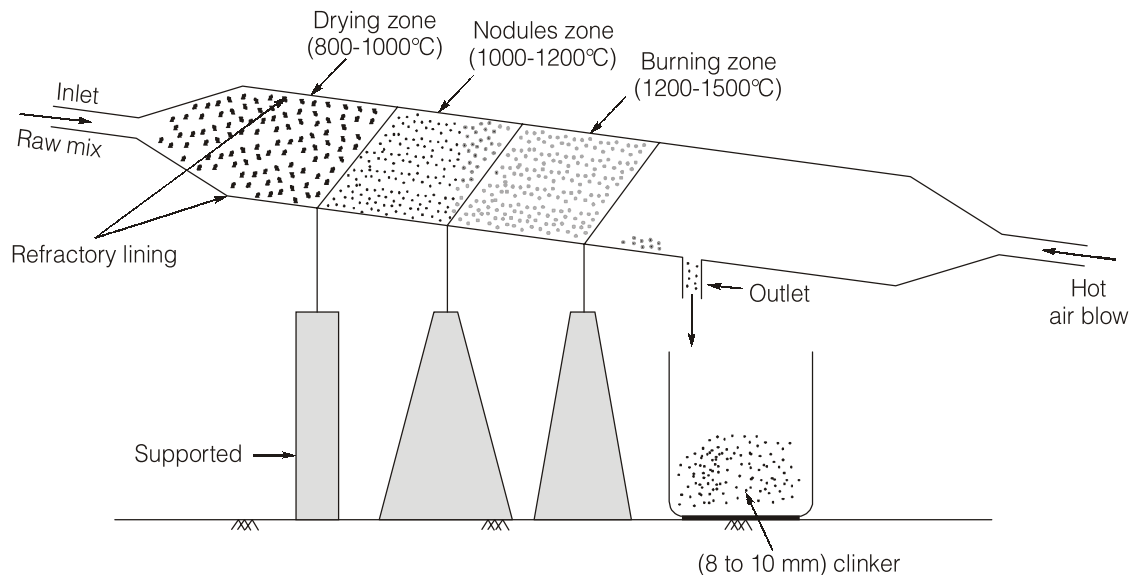

Zone-1 (Drying zone): In this zone the raw mix, is fractioned into more smaller size. In this zone if there is some water or moisture exist in raw mix then it is also evaporated.

Zone-2 (Nodule zone): In this zone, the major breakdown of raw mix occur. In this zone the calcination

of limestone takes place $\text{CaCO}_3 \xrightarrow{\text{Superheat}} \text{CaO} + \text{CO}_2 \uparrow$.
(Limestone) (Lime)

Zone-3 (Burning zone): Now, the raw mix which is also called nodules, is sloped down and the major chemical reaction between ingredient of clinker occurs i.e. lime, silica, alumina, iron oxides.

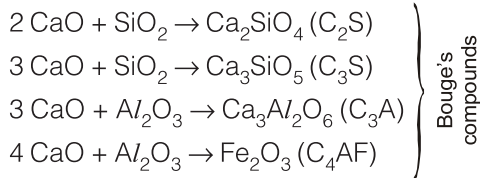

Now, from this rotary kiln the product obtained is called clinker which is composed of major and minor compounds.

NOTE: The clinker obtained has high efficiency to react with water and set immediately (flash set) to prevent this immediately setting of clinker in presence of water is done by adding gypsum in a tubemill.

(v) Now, the clinker is cooled upto temperature of 100°C , after colling it is fed into tubemill where the gypsum is also added to it, the fine grinded powder having gray colour is obtained which is called cement.

(vi) It is packed in 50 kg bag having $\pm 5\%$ volume capacity of 0.035 m^3 .

(vii) Now, after packing it is transported to dealers.

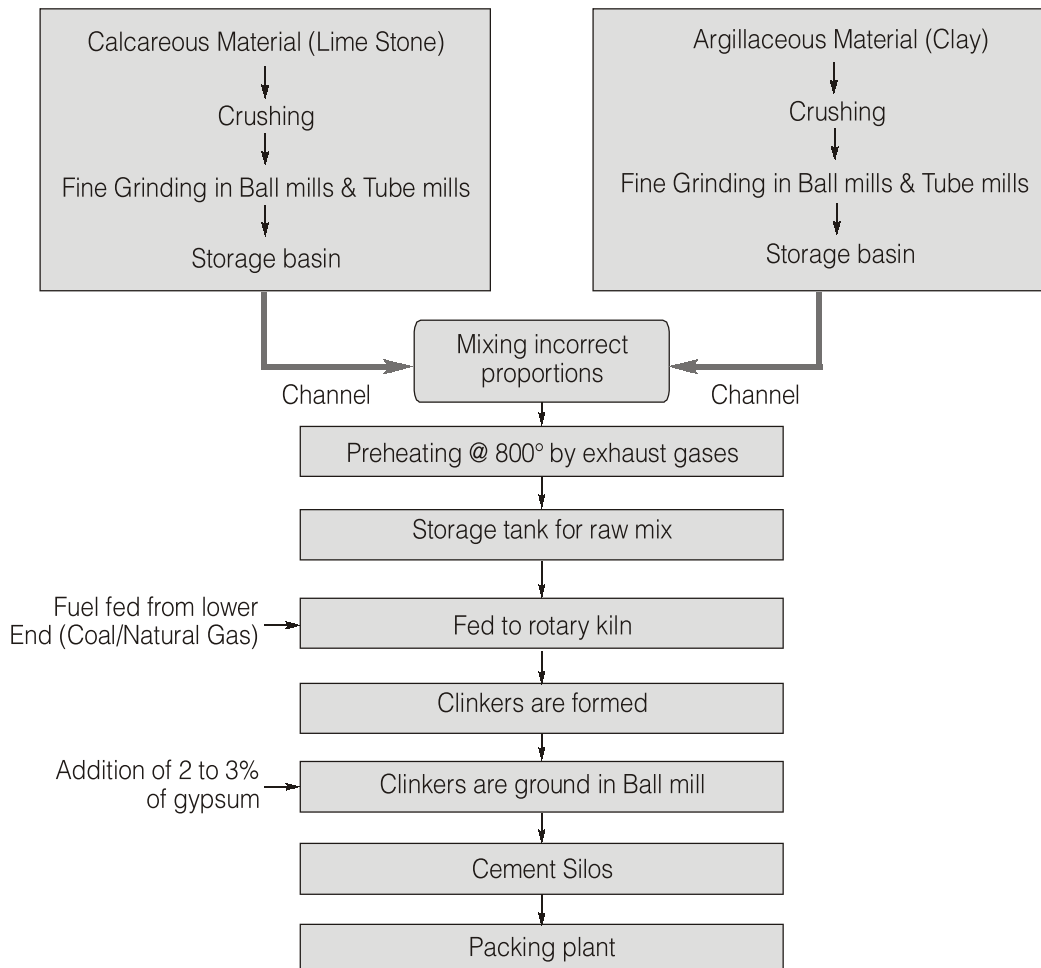

Fig: Flow diagram of dry process

Wet Process

In a wet process the heavier crushed material is made wet in storage tank before feeding into tubemill. In wet process, the preheater is not used, the mix obtained from tubemill is directly fed into rotary kiln.

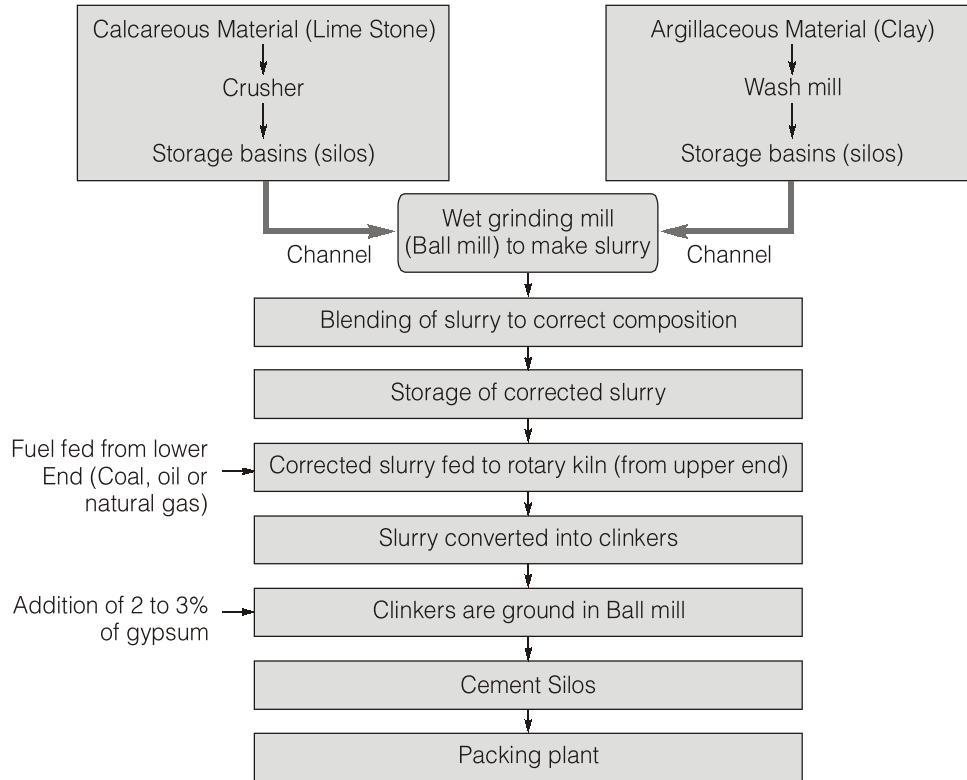

Fig. Flow diagram of wet process

Disadvantages

- (i) The process time is long.
- (ii) The fuel consumption is more.

1.4 Chemical Composition of Cement

Oxide	Composition (%)	Average
Lime CaO	60 - 65	63
Silica, SiO ₂	17 - 25	20
Alumina, Al ₂ O ₃	3 - 8	6
Iron oxide, Fe ₂ O ₃	0.5 - 6	3
Magnesia, MgP	0.5 - 4	2
Soda/or potash (Na ₂ O + K ₂ O)	0.5 - 1	1
Sulphur tri-oxide	1 - 2	1.5

- The relative proportional of three oxide compositions are responsible for influencing the various properties of cement, like lime, silica and alumina.
- An increase in lime content beyond a certain value makes it difficult to combine completely with other compounds.

- Consequently, free time will exist in the clinker and will result in an unsound cement. An increase in silica content at the expense of alumina and ferric oxide makes the cement difficult to fuse and form clinker.
1. **Lime (CaO):** If lime is provided in excess then the cement becomes unsound and if it is in deficiency then the strength is reduced therefore chances of quick setting will be enhanced.
 2. **Silica (SiO₂):** It imparts strength to the cement due to the formation of di-calcium and tri-calcium silicates. If it is in excess then the strength of the cement would be enhanced therefore setting time gets prolonged, hence it prevents quick setting.
 3. **Alumina (Al₂O₃):** It imparts quick setting property of cement. If it is in excess then the strength of cement is reduced and the chances of rapid hardening would be increased. It acts as a flux and it lowers the clinker temperature.
 4. **Calcium Sulphate (CaSO₄):** It is a retarder (admixture). If it is in excess then it slows down the quick setting which dominates to increase the strength. It is a gypsum form.
 5. **Iron Oxide (Fe₂O₃):** It imparts colour, hardness, and strength to the cement. If it is in excess, then it imparts more colour to the cement (grey).
 6. **Magnesia (MgO):** It imparts hardness and colour (yellow) to the cement, if it is in small quantity, and if it is in excess then it imparts unsoundness to the cement.
 7. **Sulphur (S):** If it is in reference quantity then it imparts strength to the cement and if it is in excess then the unsoundness is increased.
 8. **Alkalies (Soda and Potash) (Na₂O + K₂O):** The most of the alkalies present in raw materials are carried away by the flue gases heating and the cement contains only a small amount of alkalies. If they are in excess in cement then they cause a number of troubles such as alkali-aggregate reaction, efflorescence and staining when used in concrete, brick work or masonry mortar.

1.5 Basic Properties of Bougie Compounds

The principle mineral compounds in portland cement	Formula	Name	Symbol	Percentage
1. Tri-calcium silicate	3CaOSiO ₂	Alite	C ₃ S	30 - 50%
2. Di-calcium silicate	2CaOSiO ₂	Belite	C ₂ S	20 - 45%
3. Tri-calcium alluminate	3CaOAl ₂ O ₃	Celite	C ₃ A	8 - 12%
4. Tetra-calcium aluminoferrite	4CaOAl ₂ O ₃ Fe ₂ O ₃	Felite	C ₄ AF	6 - 10%

1. **Tri-calcium Silicate (C₃S):** It produces faster rate of reaction with greater heat evolution, it imparts early strength to the cement and also contributes good for ultimate strength. If it is in excess then rapid hardening enhances.
2. **Di-calcium Silicate (C₂S):** It hydrates slowly and imparts ultimate strength much. The C₂S has less heat of hydration therefore it is resistant against chemical attack.
3. **Tri-calcium Aluminate (C₃A):** It imparts fast reaction with water and it produces very high heat therefore it imparts more towards rapid hardening.
If C₃A would be more than immediate setting (flash set) would be enhanced to prevent this flash setting gypsum is added to it during manufacturing.

4. **Tetracalcium Alumino Ferite (C₄AF)** : It also reacts with water at faster rate and evolves heat by greater extent but it is more stable than C₃A because it produces less heat compared to C₃A.

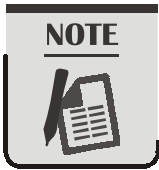

Decreasing order of ultimate: (C₂S > C₃S > C₃A > C₄AF)

Decreasing order of quickest reaction with water: (C₃A > C₄AF > C₃S > C₂S)

- The rate of hydration is increased by an increase in fineness of cement. However, total heat evolved is the same. The rate of hydration of the principal compounds is shown in figure and will be in the following descending order. C₄AF > C₃A > C₃S > C₂S

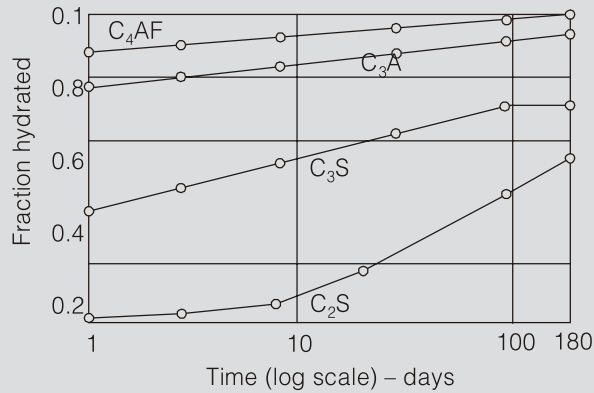

Fig. Rate of Hydration of Pure Compounds

- Rate of heat evolution of Bouge compound, if equal amount of each is considered will be in following descending order
C₃A (865 J/gm) > C₃S (865 J/gm) > C₃AF (420 J/gm) > C₂S (260 J/gm).

Compound	Heat of hydration at the given age (J/g)		
	3 days	90 days	13 years
C ₃ S	242.44	434.72	509.96
C ₂ S	50.16	175.56	246.62
C ₃ A	886.16	1299.98	1354.32
C ₄ AF	288.42	409.64	426.36

Fig. Heat of Hydration

- Development of strength of four Bouge compounds of cement with age.

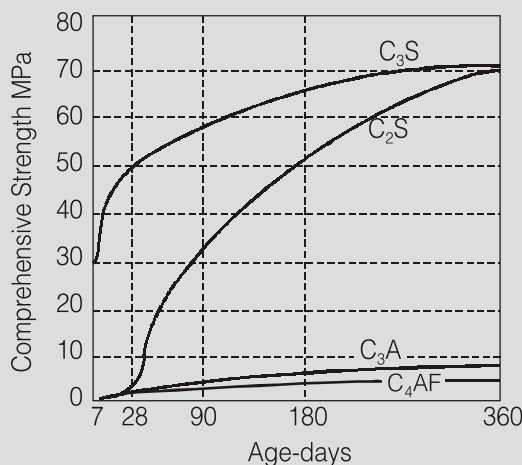

Fig. Development of Strength of Pure Compounds



STUDENT'S ASSIGNMENTS

- Q.1** The main constituent of cement which is responsible for initial setting of cement is
- Dicalcium silicate
 - Tricalcium silicate
 - Tricalcium aluminate
 - None of above
- [APPSC-2016]
- Q.2** Cement used for railway sleeper is designated as:
- 40 - s
 - 53 - s
 - 46 - s
 - 48 - s
- [APPSC-2016]
- Q.3** The apparatus used for determining the soundness of cement is
- Slump cone
 - Le-Chatelier apparatus
 - Vicat's needle
 - UTM
- [APPSC-2016]
- Q.4** Rotary kiln used in manufacturing cement rotates at a speed of
- 1 rpm - 3 rpm
 - 10 rpm - 12 rpm
 - 18 rpm - 22 rpm
 - > 25 rpm
- [BPSC-2018]
- Q.5** Which of the following is responsible for the initial set and high heat of hydration?
- Tricalcium silicate
 - Dicalcium silicate
 - Tricalcium aluminate
 - Tetracalcium alumino ferrite
- [RPSC-2013]
- Q.6** The addition of pozzolona to portland cement may cause
- decrease in early strength
 - increase in early strength
 - decrease in curing time
 - increase in permeability
- [OPSC-2016]
- Q.7** The two main compounds imparting strength for ordinary portland cement are
- tricalcium silicate and dicalcium silicate
 - dicalcium silicates and aluminates
 - tricalcium aluminates
 - tricalcium silicate and tricalcium aluminates
- [OPSC-2016]
- Q.8** Gypsum is added to portland cement during its manufacturing so that it may
- accelerate the setting time
 - retard the setting time
 - decrease the burning temperature
 - facilitate grinding
- [MPSC-2017]
- Q.9** Which is the major constituent of ordinary portland cement?
- CaO
 - MgO
 - SO₃
 - Fe₂O₃
- [MPSC-2017]
- Q.10** As per IS specification the heat of hydration of low heat portland cement for 28 days is
- not more than 100 calories/gm
 - not more than 50 calories/gm
 - not more than 75 calories/gm
 - not more than 150 calories/gm
- [MPSC-2015]
- Q.11** The following cement is used in the construction of dam
- low heat
 - rapid hardening
 - quick setting
 - sulphate resisting
- [MPSC-2015]
- Q.12** The consistency test on cement is to obtain
- tensile strength of cement
 - fineness of cement
 - percentage of water for consistent paste
 - compressive strength
- Q.13** Match **List-I (Type of cement)** with **List-II (Property/characteristics)** and select the correct answer using the code given below the lists:
- List-I**
- High strength portland cement
 - Super sulphated cement
 - High alumina cement
 - Rapid hardening portland cement

List-II

1. should not be used with any admixture
2. is extremely resistant to chemical attack
3. gives a higher rate of heat development
4. has a higher content of tricalcium

Codes:

	A	B	C	D
(a)	3	2	1	4
(b)	3	1	2	4
(c)	4	1	2	3
(d)	4	2	1	3

[HPSC-2016]

- Q.14** Consider the following statements:
- (a) Tests on cement paste to determine initial setting and final setting times are done at normal consistency.
 - (b) Low heat cement has a high percentage of tri-calcium aluminate.
 - (c) High early strength portland cement contains a large percentage of tricalcium silicate and lower percentage of dicalcium silicate.
- Which of these statements are correct?
- (a) 1 and 2
 - (b) 1 and 3
 - (c) 2 and 3
 - (d) 1, 2 and 3

[HPSC-2016]

- Q.15** Which one of the following statements regarding the fineness of cement is not correct?
- (a) Fine cement is more liable to suffer from shrinkage cracking than a coarse cement.
 - (b) Fine cement will show faster rate of hardening than coarse cement.
 - (c) Fine cement shows faster rate of heat evolution and total quantity of heat evolved is much larger than coarse cement.
 - (d) Fine cement shows the same setting time as coarse cement.

[HPSC-2016]

- Q.16** As compared to ordinary portland cement high alumina cement has
- (a) higher initial setting time, but lower final setting time.
 - (b) lower initial setting time but higher final setting time.

- (c) higher initial and final setting time.
- (d) lower initial and final setting time.

[UKPSC-2013]

- Q.17** Air permeability test is done to measure
- (a) setting time of cement
 - (b) soundness of cement
 - (c) chemical composition of cement
 - (d) fineness of cement

[KPSC-2015]

- Q.18** I and P is the standard consistency of cement the amount of water used in conducting the initial setting time test on cement is
- (a) 0.65 P
 - (b) 0.85 P
 - (c) 0.6 P
 - (d) 0.8 P

- Q.19** Which of the following pairs in respect of Ordinary Portland Cement (OPC) are correctly method?
1. Initial setting time - 30 minutes
 2. Final setting time - 10 hours
 3. Normal consistency - 10%
- Select the correct answers using the codes given below:
- (a) 1, 2 and 3
 - (b) 2 and 3
 - (c) 1 and 2
 - (d) 1 and 3

- Q.20** The temperature range in a cement kiln is
- (a) 500°C to 1000°C
 - (b) 1000°C to 1200°C
 - (c) 1300°C to 1500°C
 - (d) 1600°C to 2000°C

- Q.21** The fineness of cement is tested by
- (a) air-content method
 - (b) air-permeability method
 - (c) Le-chatatier apparatus
 - (d) Vicat's apparatus

- Q.22** For marine works the best suited cement is ____.
- (a) low heat portland cement
 - (b) rapid hardening cement
 - (c) ordinary portland cement
 - (d) blast furnace slag cement

- Q.23** Ultimate strength of cement is influenced which one of the following?
- (a) Tricalcium silicate
 - (b) Dicalcium silicate
 - (c) Tricalcium aluminate
 - (d) Tetracalcium alumina ferrite

- Q.24** One bag of portland cement, 50 kg in weight, would normally have a bulk volume of
(a) 30 l (b) 35 l
(c) 40 l (d) 45 l
- Q.25** Before testing setting time of cement one should test for
(a) soundness (b) strength
(c) fineness (d) consistency
- Q.26** Soundness test of cement is done/carried to determine its
(a) alumina content
(b) iron oxide content
(c) free lime content
(d) durability under sea water
- Q.27** Fineness of cement is measured in the units of
(a) volume/mass (b) mass/volume
(c) area/mass (d) mass/area
- Q.28** The test on cement designed to accelerate the slaking process of the ingredient of cement and to determine the resulting expansion in a short time is
(a) setting time test
(b) soundness time
(c) normal consistency test
(d) accelerated test
- Q.29** Increase in fineness of cement
(a) reduces the rate of strength development and leads to higher shrinkage.
(b) increase the rate of strength development and reduces the rate of deterioration.
(c) decreases the rate of strength development and increases the bleeding of cement.
(d) increases the rate of strength development and leads to higher shrinkage.
- Q.30** High alumina cement is produced by fusing together a mixture of
(a) limestone and bauxite
(b) limestone, bauxite and gypsum
(c) limestone, gypsum and clay
(d) limestone, gypsum, bauxite, clay and chalk
- Q.31** The density of cement is taken as
(a) 1000 kg/m³ (b) 1250 kg/m³
(c) 1440 kg/m³ (d) 1800 kg/m³
[SSC-JE-2014]
- Q.32** The high early strength of rapid hardening cement is due to its
(a) increased content of gypsum
(b) burning at high temperature
(c) increased content of cement
(d) higher content of tricalcium silicate
[SSC-JE-2014]
- Q.33** The fineness of cement can be found out by sieve analysis using IS sieve number
(a) 20 (b) 10
(c) 9 (d) 6
[SSC-JE-2014]
- Q.34** Di-calcium silicate (C₂S)
(a) hydrates rapidly
(b) generates less heat of hydration
(c) hardness rapidly
(d) has less resistance to sulphate chalk
[SSC-JE-2014]
- Q.35** Out of the constituents of cement namely: Tricalcium silicate (C₃S), Dicalcium silicate (C₂S), Tricalcium aluminate (C₃A) and tetracalcium alumino ferrite (C₄AF), the first one to set and harden is _____.
(a) C₃A (b) C₄AF
(c) C₃S (d) C₂S
[SSC-JE-2012]
- Q.36** The standard consistency test is done in a
(a) Blaine's apparatus
(b) Le-chatalier apparatus
(c) Vane apparatus
(d) Vicat's apparatus
[SSC-JE-2011]
- Q.37** The volume of one bag of cement is
(a) 0.0214 m³ (b) 0.0347 m³
(c) 0.0434 m³ (d) 0.0609 m³
[SSC-JE-2011]
- Q.38** Good quality cement contains higher percentage
(a) tricalcium silicate (b) tricalcium aluminate
(c) dicalcium silicate (d) none of the above
[SSC-JE-2010]
- Q.39** During the manufacture of cement, gypsum or plaster of Paris is added to
(a) increase the strength of cement

- (b) modify the colour of cement
- (c) reduce heat of hydration of cement
- (d) adjust setting time of cement

[SSC-JE-2013]

Q.40 Which of the following type of lime is used for underwater constructions?

- (a) Fat lime
- (b) Quick lime
- (c) Slaked lime
- (d) Hydraulic lime

[SSC-JE-2014]

Q.41 The percentage of water for normal consistency is _____.

- (a) 5% to 15%
- (b) 10% to 25%
- (c) 15% to 25%
- (d) 20% to 30%

[SSC-JE-2017]

Q.42 Flash set of ordinary portland cement paste is _____.

- (a) premature hardening
- (b) surface hardening only
- (c) hardening without development of heat of hydration
- (d) all the options are correct

[SSC-JE-2017]

Q.43 Efflorescence in cement is caused due to an excess of _____.

- (a) alumina
- (b) iron oxide
- (c) silica
- (d) alkalis

[SSC-JE-2017]

Q.44 The commercial name of white and colored cement in India is

- (a) colocrete
- (b) rainbow cement
- (c) silicrete
- (d) all options are correct

[SSC-JE-2017]

Q.45 The minimum percentage of chemical ingredient of cement is that of

- (a) magnesium oxide
- (b) iron oxide
- (c) alumina
- (d) lime

[SSC-JE-2017]

Q.46 A sample of cement is said to be sound when it does not contain free

- (a) lime
- (b) silica

- (c) iron oxide
- (d) alumina

[SSC-JE-2018]

Q.47 The main purpose of the soundness test of the cement is to determine the _____.

- (a) change in volume of cement after setting
- (b) strength
- (c) fineness
- (d) time taken to harden

[SSC-JE-2018]

Q.48 Which of the following shows the correct decreasing order of rate of hydration of portland cement compounds?

- (a) $C_3A > C_4AF > C_3S > C_2S$
- (b) $C_3A > C_4AF > C_2S > C_3S$
- (c) $C_3A > C_3S > C_4AF > C_2S$
- (d) $C_4AF > C_3S > C_3A > C_2S$

[SSC-JE-2018]

Q.49 In fineness test rapid hardening portland cement the residue on IS sieve number 9 should not be more than

- (a) 0.01
- (b) 0.05
- (c) 0.1
- (d) 0.15

[SSC-JE-2018]

Q.50 For construction of structures in sea water, the cement generally preferred to is

- (a) portland pozzolona cement
- (b) quick setting cement
- (c) low heat portland cement
- (d) none of these

[SSC-JE-2018]

ANSWER KEY // STUDENT'S ASSIGNMENTS

1. (c)	2. (b)	3. (b)	4. (a)	5. (c)
6. (a)	7. (a)	8. (b)	9. (a)	10. (c)
11. (a)	12. (c)	13. (a)	14. (b)	15. (c)
16. (a)	17. (d)	18. (b)	19. (c)	20. (c)
21. (b)	22. (d)	23. (b)	24. (b)	25. (d)
26. (c)	27. (c)	28. (b)	29. (d)	30. (a)
31. (c)	32. (d)	33. (c)	34. (b)	35. (a)
36. (d)	37. (b)	38. (c)	39. (d)	40. (d)
41. (d)	42. (a)	43. (d)	44. (d)	45. (a)
46. (a)	47. (a)	48. (c)	49. (b)	50. (a)

1. (c)

Tricalcium aluminate (C_3A) hydrates and hardens the quickest. It liberates a large amount of heat almost instantaneously and contributes somewhat to early strength.

2. (b)

Cement used for railway sleeper is designated as 53-S. It is because the cement used is OPC grade 53 i.e. ordinary portland cement with strength 53 MPa.

3. (b)

Soundness test: The purpose of this test is to detect the presence of uncombined lime in cement 'or' to detect the change in volume of cement after setting. It is performed with the help of:

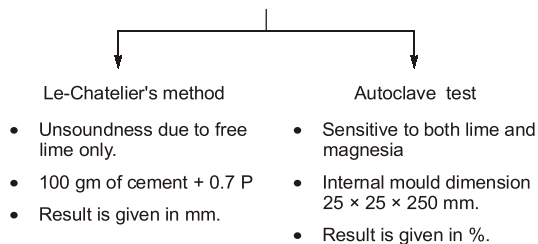
**4. (a)**

The rotary kiln rotates at about 1-3 revolutions per minute about its longitudinal axis.

5. (c)

C_3A (tricalcium aluminate) reacts with water in the start of hydration and generates heat of hydration at fast rate. So lower C_3A will generate less heat. The ultimate strength depends upon C_3S and C_2S . Lower C_3A means higher C_3S and C_2S and higher ultimate strength.

The product of hydration are calcium hydroxide $Ca(OH)_2$ and calcium silicate hydrate ($C_3S_2H_3$), a gel structure.

6. (a)

Addition of pozzolana reduces the initial rate of increase in strength.

7. (a)

C_3S and C_2S together constitute about 70% of cement and are responsible for providing most

of the strength to it C_3A is responsible for flash set and C_4AF generates very less strength.

8. (b)

During the manufacturing of Portland cement, admixtures are added which influence the properties according to our desired values. Gypsum acts as retarder and is added to slow down the reaction. Whereas calcium chloride is an accelerator and is used to speed up the reaction.

9. (a)

Constituents of OPC:
Lime CaO (60-65%)
Silica SiO_2 (11-25%)
Alumina (3-8%) and so on.

10. (c)

As per IS code specifications, the heat of hydration of low heat portland cement for 28 days is not more than 75 calories/gm.

11. (a)

Since, low heat cement has very low heat of hydration which is suitable for mass concreting such as dams.

12. (c)

The consistency test on cement is to obtain that particular percentage of water which allows the plunger to penetrate only to a depth of 33 to 35 mm from the top (or 5 to 7 mm from the bottom) in the vicat mould.

13. (a)

- C_3S gives high strength portland cement.
- Super sulphated cement is resistant to sulphate attack and also to chemical attack.
- High alumina cement cannot be used with admixtures.
- RHC gives higher rate of heat development due to increased rate of reaction.

14. (b)

Low heat cement: The considerable heat is produced during the setting action of cement. In